



5610 Rose Loop NE  
Bainbridge Island, WA, USA 98110  
(520)780-9030; (206)219-4205 FAX  
<http://www.highvoltageprobes.com>  
[probes@highvoltageprobes.com](mailto:probes@highvoltageprobes.com)

**Voltage Probe Manual and Data  
North Star High Voltage, Inc.  
Rev November 2018**



**Safety**

**High Voltage Safety is important. Always ground the probe to a reliable ground point near the measurement point. Do not touch the probe during high voltage operation. Stay away from malfunctioning high voltage equipment and ground it carefully if it must be touched. Failure to ground the probe near the device under test can also destroy the probe.**

**13.56 Mhz users should use a 0 ohm series resistor for PVM1..PVM6**

## General

The PVM and VD series high voltage probes are RC dividers designed to produce precisely attenuated signals over a very wide bandwidth. The circuit diagram is shown below. The divider network consists of a high voltage network represented by a parallel capacitor and resistor, and a low voltage network which consists of a parallel RC network and a compensation circuit. The high voltage section of the voltage divider is in a polypropylene or FR4 oil filled housing. The low voltage section is in the small rectangular box or circuit board inside the bottom of the handle (PVM series probes) or in the small rectangular box underneath the probe base (VD series probes). The purpose served by placing the low voltage section in a secondary enclosure is that it reduces noise and simplifies the calibration procedure. Additional compensation for high frequencies is used in the PVM-2 and PVM-6.

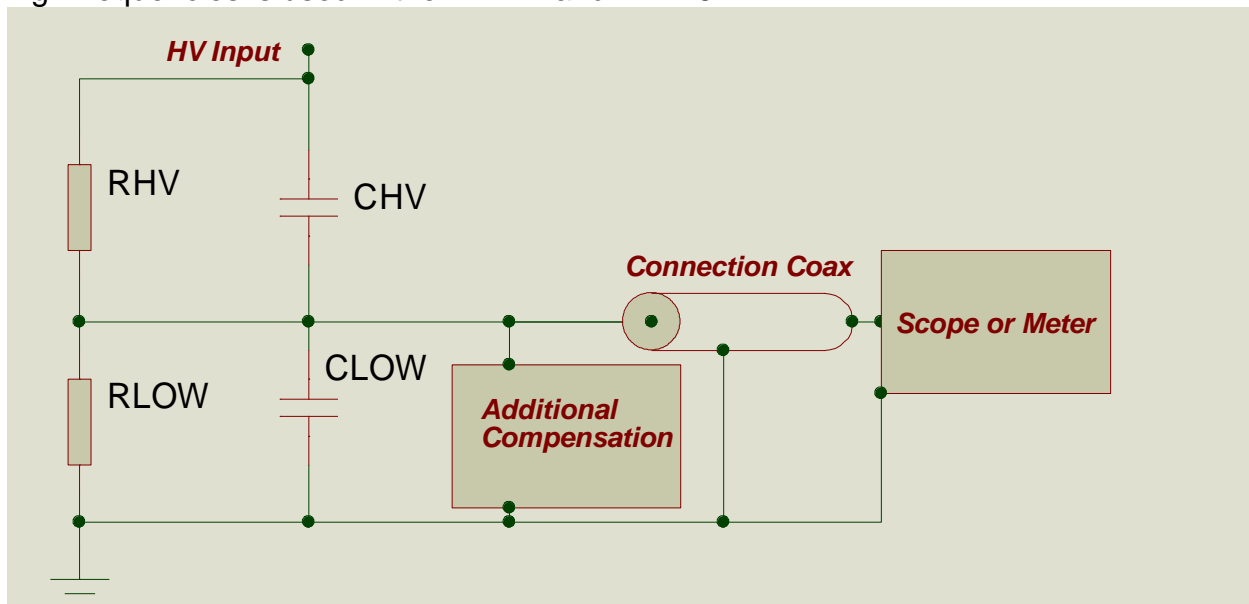

Generalized Probe Configuration

The probe is designed to produce the calibrated level of output with a 1 Megohm impedance on the measurement device, and with the specified cable length in place. Changes in cable length tend to change the calibration approximately 0.5 %/ft. for a typical 1000:1 probe. The 10,000:1 probes, including the VD series probes, have smaller variations in calibration with cable length.

The high voltage section of each probe is insulated with Shell Diala-AX or Ergon Hivolt transformer oil which does not contain PCBs. The oil does not have any known toxic effects. It is the same transformer oil used throughout the world in distribution transformers. People who have grid electricity are usually within 1 km of an oil-filled transformer. Usually much closer.

## **Input Impedance for Standard Operation**

Standard probes are designed to operate into a 1 megohm oscilloscope. Operation into higher impedance devices such as multi-meters requires a parallel resistance for accurate measurement. For example, a 1.111 Megohm resistance can be placed in parallel with a yellow Fluke meter (10 Megohm input) to produce a 1 Megohm input impedance. Operation into lower impedance equipment requires factory changes. Read the manual of your measuring instrument to determine its input impedance since many meter manufacturers use different input impedances on different meter scales. Erroneous readings will result with all passive probes (not just our probes) when the wrong measurement impedance is used.

## **Proximity Effect and Exclusion Zone for VD and PVM11/12 Probes**

The “proximity effect” (change in calibration when the probe is near ground or near a high voltage node) has been reduced or eliminated in all NS probes. Good practice and high voltage safety still dictate that the probe should be spaced away from other conductors by a distance of at least 3 mm/kV rated (15 cm if the DC voltage is 50 kV). This is particularly true of DC voltage and repetitive AC voltage. A high frequency ( $f > 50$  Hz) calibration shift of about 0.5 - 1 % is possible if conductors are closer.

## **Proximity Effect for PVM-1 – PVM-7, PVM-100**

The PVM-1 – PVM-7 use a unique shielded design which both reduces proximity effects and increases the “speed” of measurement into the low nanosecond regime. Proximity effect at reasonable distances (10 cm) are too low to measure in the PVM1- PVM7 probes. The PVM-100 also has a shielded design. The PVM-11/12 do not have fully shielded designs.

## **High Frequency Measurements**

It may be necessary to improve the grounding of the probe in order to clean up noise in very high voltage, high frequency ( $> 20$  Mhz) measurements. Specifically, a wide area ground from the bottom of the probe, or additional individual grounds may be required. It may also be necessary to further shield the probe cables at the highest frequencies. The cause of noise is often the ground loop which results if the probe cable carries some of the ground current. Inductive isolators on the probe signal cable can also be helpful in “choking” ground currents. Note that the impedance presented by the probe to the source at 50 Mhz with a probe with 8 pf. Input capacitance is only 400 ohms, so currents matter at high frequencies. Higher currents occur at higher capacitance.

## **Connections**

In general, the ground clip lead should be connected to the ground of the equipment under test, and the tip of the probe should be connected to the voltage source for PVM series probes. For VD series probes, the signal is connected to the top of the probe,

and the ground is connected to the base. At high frequency, the inductance of the ground path must also be minimized. One method of improving high speed measurement is to use multiple grounds in addition to the black ground lead provided (PVM probes). The cylindrical ground shield can also be used for ground connections. Wide area and large diameter conductors can be helpful in reducing inductance which is important for measurements involving frequencies above 10 Mhz (30 ns rise of faster).

Connections should be made with the equipment to be measured turned off. The BNC output cable should be connected directly to the oscilloscope, and in general the oscilloscope should be grounded. An RG-223 cable (double shielded cable) is provided with all probes. The double shielded cable is essential at high frequencies and it is advantageous at low frequencies. Any 50 ohm (or 93 ohm if appropriate) cable can be used to connect to the measurement instrument as long as that cable has the right capacitance, but single shielded cables have more noise than the double shielded cables we always provide.

It is important to avoid setups where the current of the source returns through the ground shield of the probe. The probe is not designed for this, and the IR drop or  $L(di/dt)$  over the cable appears as an erroneous signal at the oscilloscope.

### **Changing the Cable**

We recommend that if a different cable than the originally supplied cable is to be used, it should be made from RG-223 cable (except for 93 ohm cable probes) and kept to the same length as the original cable. Connectors can be placed in this cable (for example for penetrating screen room walls). Double shielded cables (RG-223) reduce spurious noise, leading to better performance. RG-223 has a capacitance of ~ 30.8 pf/ft.

### **Troubleshooting**

Repair of most probe problems will lead to a requirement for re-calibration. If there is a problem, dis-assembly of the probe high voltage section is not recommended. Except in unusual situations, North Star will repair the probe without question if it is under warranty. It is much easier for us to ascertain the problem if the probe has not been modified by the user when it is returned to us.

If the probe has no signal output, but is not shorted to ground, the problem may be a poor connection in the tap-off box. The tap-off box can be inspected, and if wires are loose they should be reconnected. Do not adjust the potentiometers in the tap-off box, or re-calibration will be required.

The largest source of problems is systems which have an unexpected input impedance different from 1 Meg (subject to the presence of the switch option).

## Removable Series Damping Resistor and Metal Insert

PVM-1...PVM-7 and PVM-100 probes may use a series damping resistor to damp high frequency oscillations. In some cases we can avoid this by using a zero ohm insert. The insert is intentionally removable because in some cases (13.56 Mhz signals of high amplitude for example) the resistor can overheat and fail. The second reason that it is removable is that we require an external sealing nut, and we found that some customers would see this nut, overtighten it (even if not loose), strip the thread in the plastic, and create a leak. For this reason the series damping resistor is rotatable and for this reason cannot be overtightened even by those with the best of intentions. We have a new high power integral semicustom resistor, and problems with the new resistor have been minimal. The resistor uses an M4 threaded banana plug. If you require a zero ohm insert please request one at the time of ordering the probe.

### Standard Probe Data

**Note that for AC from 1 Hz - 400 Hz AC RMS operating voltage = DC voltage/1.41**

Model Number	PVM-1	PVM-2	PVM-3	PVM-4	PVM-5	PVM-6	PVM-7	PVM-100	PVM-11	PVM-12
Max DC/Pulsed V (kV)	40/60	40/60	40/60	40/60	60/100	60/100	60/100	100/150	10/12	25/30
Max Frequency (Mhz.)	90	90	25	120	80	80	120	90	50	60
Cable Impedance (ohms)	50	50	50	50	50	50	93	50	50	50
Risetime (ns)	3.3	3.3	12	2.5	3.5	3.5	2.5	3	6	5
DC - 2 Hz.accuracy	<0.1%	<0.1 %	<0.15 %	<0.1 %	<0.15%	<0.15%	<0.15 %	<0.15 %	<0.15 %	<0.15 %
2 Hz. - 200 Hz. accuracy	<1 %	<1. %	<2. %	<1. %	<1%	<1%	<1.5 %	<1.5 %	<1.5 %	<1.5 %
200 Hz. - 5 Mhz. accuracy	<1.5%	<1.5%	<3%	<1.5%	<1.5 %	<1.5 %	<2.%	<2.%	<2.%	<2.%
> 5 Mhz. Accuracy	<4%	<5%	<4%	<5%	<3%	<6%	<6%	<6%	<4%	<4%
Input R/C (Megohm/pf)	400/13	400/13	400/10	400/10	400/12	400/12	100(50)/15	300/7	100(50)/15	300/7
Cable Length (ft./m)	15/4.5	30/9	100/30	15/4.5	15/4.5	30/9	15/4.5	15/4.5	15/4.5	15/4.5
Standard Divider Ratio	1000:1	1000:1	10,000:1	1000:1	1,000:1	1,000:1	1,000:1 (100:1)	1,000:1	1,000:1 (100:1)	1,000:1
Length (inches/cm.)	19/47	19/47	19/47	19/47	19/47	19/47	7/18	9/23	7/18	9/23

Add -2 to any PVM-1 – PVM-6, PVM-11 or PVM-12 part number for 2000:1 ratio

## VD Probe Data

**Note that for AC from 1 Hz - 400 Hz AC RMS operating voltage = DC voltage/1.41**

Model Number	VD-60	VD-100	VD-150	VD-200	VD-300	VD-400
Max DC/Pulsed V (kV)	60/105	100/180	150/240	200/300	300/420	400/550
Max Frequency (Mhz.)	20	20	20	16	12	8
Cable Length (ft.)	30	30	30	30	30	30
DC accuracy	<0.1 %	<0.1 %	<0.1%	<0.1%	<0.2 %	<0.2%
10 Hz. - 1 Mhz. Accuracy	1 %	1 %	1 %	2%	3 %	5 %
>1 Mhz Accuracy	3 %	3 %	3 %	3%	4 %	4%
Resistance (Megohms)	800	1600	2000	2800	2250	3500
Height (inches/cm.)	20/50	24/60	30/75	40/99	54/135	72/180
Diameter (in/cm.)	11/28	11/28	12/29	16/40	24/61	24/61
Capacitance (approx. pf)	27	25	27	24	20	16
Base Diameter(in/cm.)	10/25	10/25	12/30	20/50	30/76*	30/76*
Standard Divider Ratio	10,000:1	10,000:1	10,000:1	10,000:1	10,000:1	10,000:1

\*Square Base

## Warranty

The probe is warranted against defects in parts and workmanship for one (1) year after the ship date from North Star. We will repair the probe if an electrical failure occurs during the first six (6) months after shipping irrespective of the cause of the fault. Shipping from the customer site to North Star will be paid by the customer, and shipping from North Star to the customer will be paid by North Star. North Star will judge whether expedited means of shipping are required.

Mechanical damage due to dropping the probe and thermal damage may not be covered and should be discussed with North Star before returning the probe. Shipping damage should be reported to North Star immediately. Please do not open the probe high voltage section if warranty repairs are going to be requested.

## Additional Resources

If you need a pulsed power formula try our pulsed power formulary. Download our well-known Pulsed Power Formulary at our web site:  
<http://www.highvoltageprobes.com/downloads.html>

Very high voltage pulsed measurements with capacitive sensors and integrators - coming soon at <http://www.highvoltageprobes.com/downloads.html>

## HV Limits

The HV limits are determined by dielectric strength issues and in some cases by derating. In general a North Star probe has a pulse and a DC value. The DC value reflects the maximum DC value or continuous value of voltage the probe can be used at. For example the PVM-1 has a 40 kV continuous DC rating. There is no duty cycle limitation for any of our DC ratings on standard products.

For 50/60 Hz continuous signals in all probes:

**Peak AC rating = DC rating => RMS AC Voltage Limit = DC Voltage Limit/1.41**

Continuous is half a cycle or more (8 – 10 milliseconds)

## Pulse Rating

The pulse rating reflects the fact that pulses of short duration interact with insulation in a more predictable manner than pulses of long duration (or DC). For example in a DC insulator charges move in a complex manner determined by local conductivity. During a short pulse such motion does not have time to occur. It also reflects the fact that the probes are inherently air insulated, and charge motion in air can occur over longer time scales. These phenomena are complex and so we have developed approximate rules to determine what the time scales are.

Examples of Applicability of Pulse Voltage Rating:

Full pulse rating at 1 Hz/10 usec pulse duration or shorter  
1.5 X DC for VD series to 300 Hz/10 usec pulse duration  
1.25 X DC for VD series to 4 kHz/10 usec pulse duration  
1.25 X DC for PVM series to 300 Hz/10 usec pulse duration

The transition between pulse and DC is not well defined but lies somewhere between 10 usec and 1000 usec.

Specific examples:

Single pulse EMP Pulses	The full PVM pulse rating may be used.
Lightning (1.2 us rise and 50 us fall)	The full PVM pulse rating may be used.
Single cycle AC (8 – 10 ms half sine) value	The DC value should equal the Peak AC value
Automotive Ignition waveform (3600 RPM)	1.33XDC value for peak pulse voltages
RF Accelerator (300 Hz, 10us)	1.25XDC value for peak pulse voltage
Max rep rate for 10 us pulses at full pulse V	1 Hz

## Derating in North Star Probes

Derating in HV probes in general, and North Star High Voltage HV probes specifically results from heating due to AC dielectric loss and capacitive ESR (equivalent series resistance). These are fundamentally AC (time dependent) effects which result as charges and polarization move in the dielectric. In the absence of time dependent applied signals (ie DC) no derating is required. **The derating is the reduction from the peak DC voltage. In no case does the derating allow the user to exceed the limits discussed above.**

North Star probes have dielectrics chosen to have low loss. In the limit where the loss tangent  $\tan\delta$  is fixed with frequency (true of both Teflon and C0G/NP0 dielectric materials)

$$P \sim 2f(\tan\delta)\left(\frac{1}{2}CV^2\right)$$

If the frequency is discontinuous over time periods faster than 0.1 second or so, the frequency is the average frequency of the event. For example if we have 20 Mhz for 10 % of the time over 0.1 seconds, that is effectively 2 Mhz.

We can calculate the max number of cycles in a burst without derating as follows:  $F_{max}$  = max frequency with no derating (about 2 Mhz for a PVM-12).

Number of cycles in a burst of any frequency above  $F_{max}$  without derating =  $0.1 * 2 \text{ Mhz}$  = 200,000 cycles. So 200,000 cycles of 40 Mhz is OK with a duty cycle of 1/20 or 5 %.

PVM-12 Derating - AC

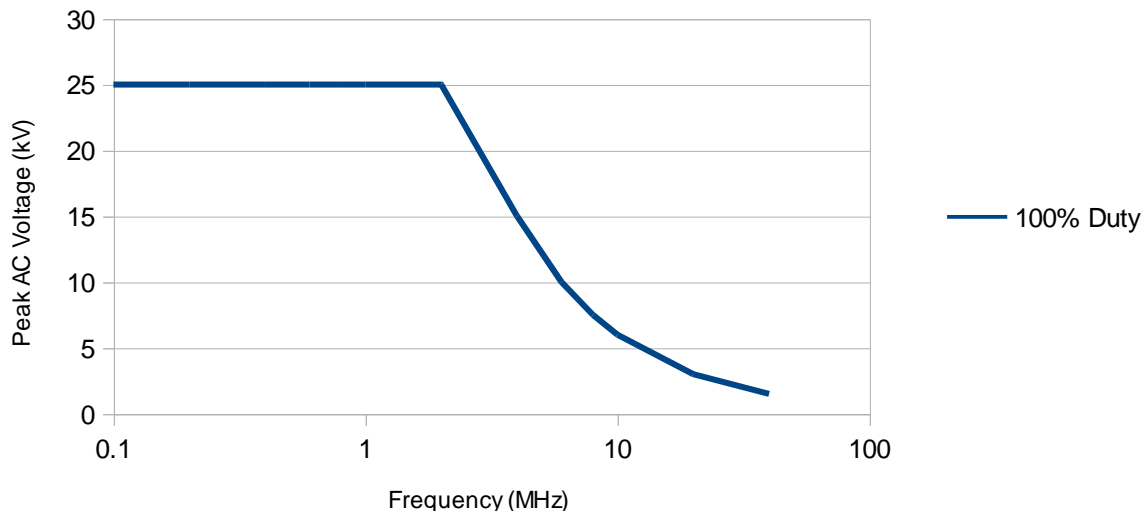



### PVM-1, PVM-2, PVM-3 Derating - AC

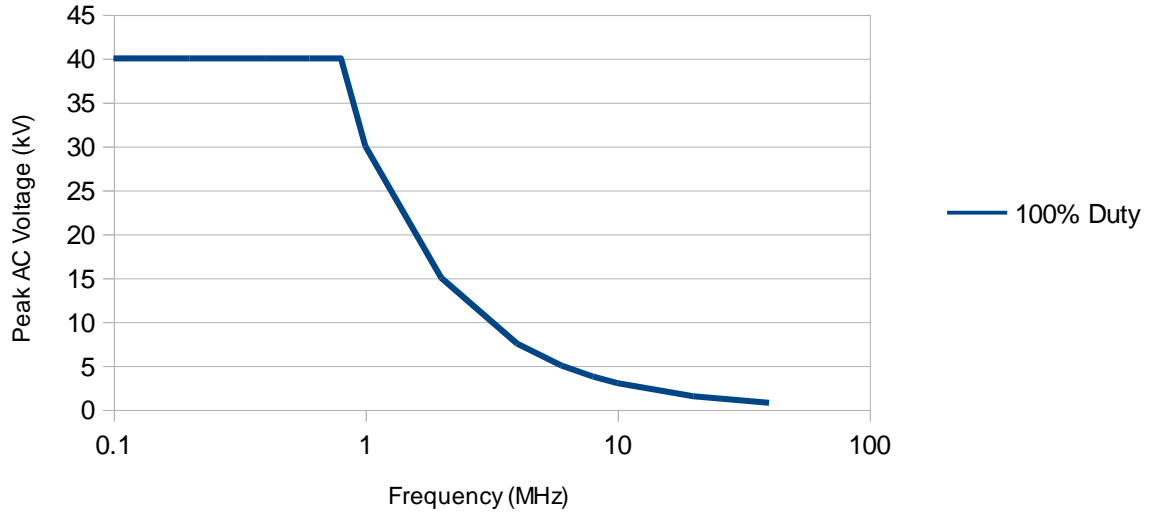

### PVM-5, PVM-6 Derating - AC

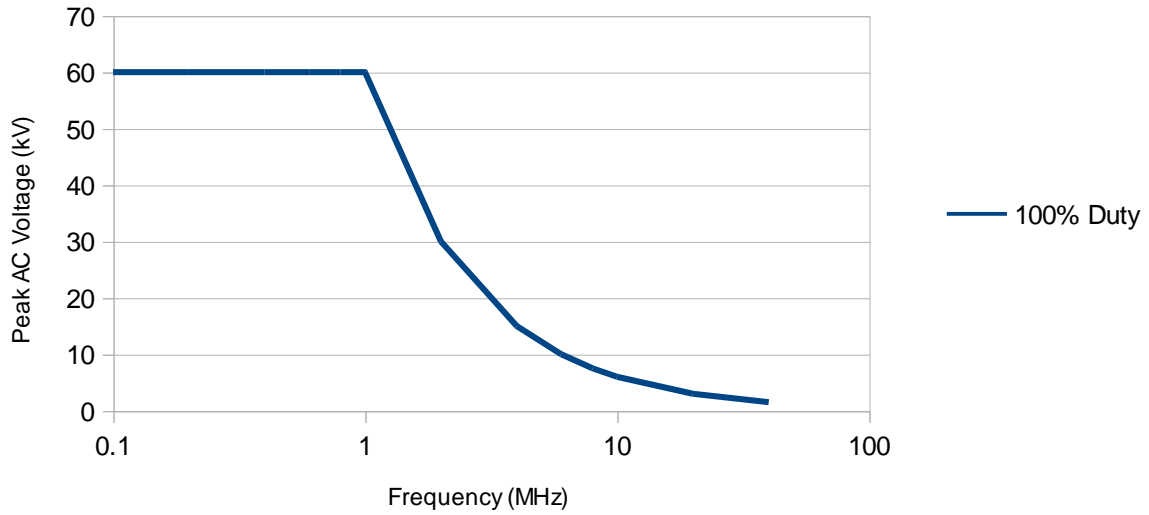

Above ratings are for the probe with a zero ohm metal insert for the series damping resistor. These are average frequencies. For example if the frequency is 10 Mhz in burst of 1% duty cycle the frequency is 100 kHz and no derating is required.

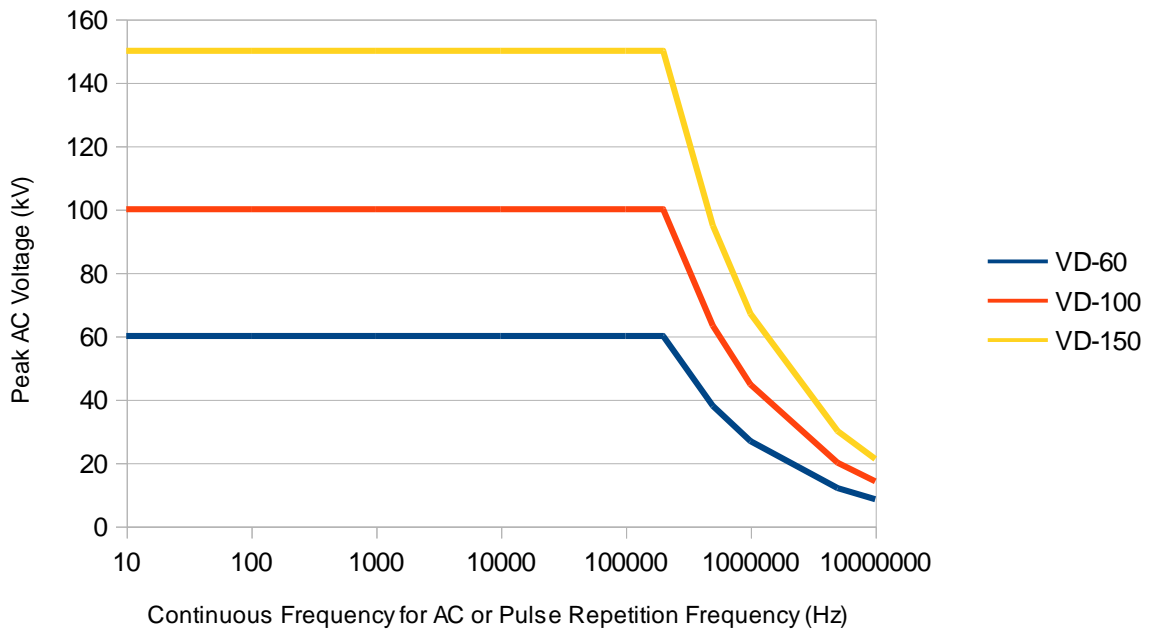
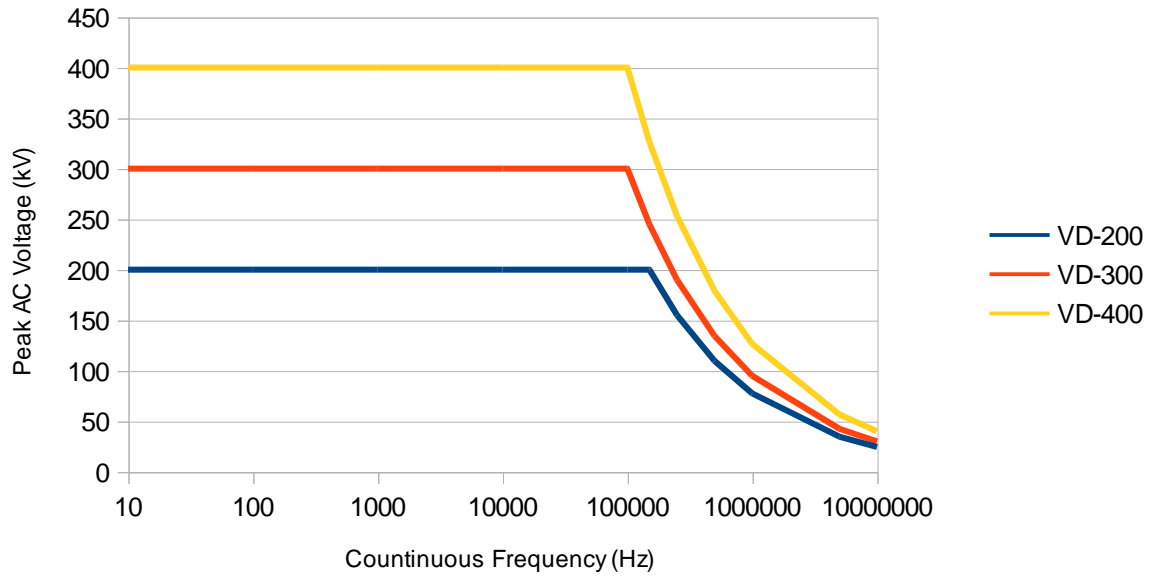

## Series Damping Resistor – Repetition Rate and Average Power Limitations

The purpose of the resistor at the front of the on the PVM-1...PVM-7 and PVM-100 is to damp oscillations at frequencies above about 35 Mhz or for risetimes of 10 ns or faster. It generally damps higher frequencies >100 Mhz for PVM-1,2,3,5,6, and >150 Mhz for PVM-4 and PVM-7. The resistor offers no benefit for lower frequencies. Because the resistor is dissipative at high frequencies, it creates a more restrictive limit for probe “derating”. Both 50 and 80 ohm damping resistors are in use. Note that the curve below is for 50 ohms.

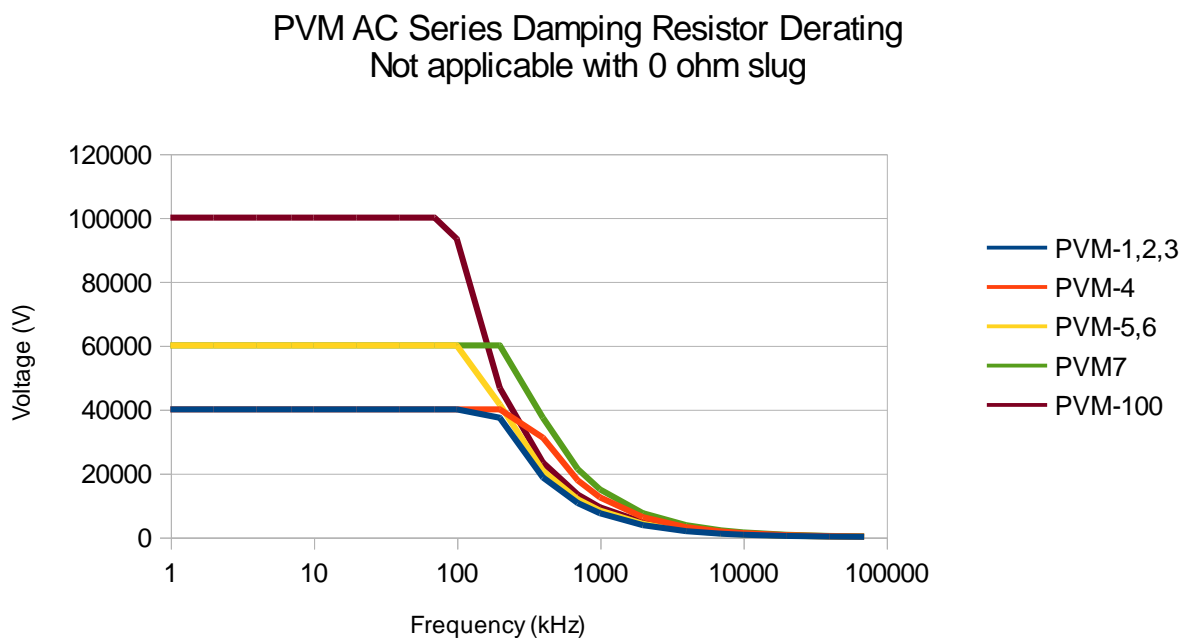

The above values are for 50 ohm damping resistors only.

For Pulses with a Risetime  $T_r$  (10-90) the max repetition rate is described by the following equation:

$$\text{Max Rep Rate} = 2.8 \cdot 10^{11} T_r / (C^2 V^2)^5$$

Tr in microseconds, V in kV, C in pf

**C= 10 PVM1,2,3**

**C= 8 PVM4**

**C= 9 PVM5,6**

**C= 5 PVM7**

**C= 8 PVM-100**

Example: PVM-7, 5 pf V=80 kV,  $T_r=0.01$  us Max Rep =  $2.8e11 \cdot .01 / (5 \cdot 80)^2 = 17$  kHz

Example PVM-1 10 pf V=50 kV Tr= 0.005 us Max Rep = 5.6 khz